

Along for the Ride

Z1210



Z1210 Storage Pod

ZTechnik's extremely versatile 4-liter rear storage compartment is a great addition or alternative to the standard tank bag. Besides its cavernous main compartment, four zippered storage areas (three main areas and one document holder) are attached to a cleverly designed, removable tray. A Velcro® hinge makes removal of the tray a snap.

Sturdy double zippers keep everything secured inside while the pod's web straps and rubber coated hooks attach it to the bike. Thinking ahead, ZTechnik included plenty of length in the web straps to make mounting the bag – under the seat, to the rear tail cowl, or through a rack – an easy process.

Material

The dense thermo-molded pod is covered with a durable canvas outside with a soft inner shell.

Size

- H: 6.00-4.50" (15.2-11.4cm) front to back
- W: 12.50-9.00" (31.8-22.9cm) front to back
- L: 13.75" (35.0cm)

The Storage Pod's rubber coated hooks on adjustable nylon straps won't scratch or mar your motorcycle's finish.



Three main storage pockets plus map compartment

Removable Upper Tray



The ZTechnik Storage Pod fits a wide range of older and current model BMW motorcycles, as well as almost any other make of sport/touring or standard bike.

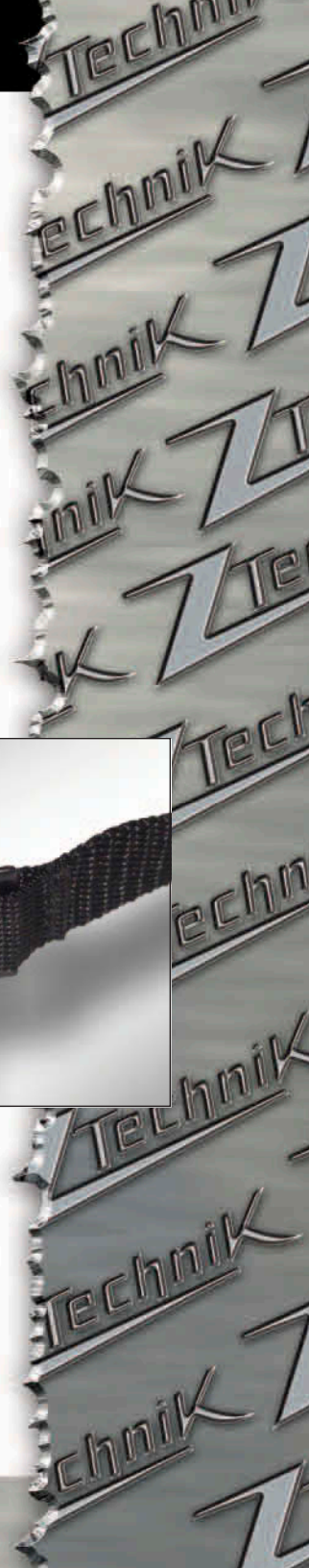

Lock It or Lose It

Z5505 Helmet Lock

The ZTechnik Helmet Lock for BMW motorcycles uses the license plate bracket to provide storage for two full-face helmets. A sturdy push lock accepts D-ring or web strap loop helmet closures. Simply place the D-ring on the platform behind the post and push the post down. Your helmet is automatically locked and secured.

The ZTechnik Helmet Lock is manufactured from high strength steel and finished in durable black powder coat. It comes with two matched keys.



U.S. Customers: Wisconsin State Department of Transportation does not comply with SAE license plate standards. Only the top two holes of Wisconsin plates align with the Z5505 Helmet Lock backing plate.



The ZTechnik Helmet Lock fits a wide range of older and current model BMW motorcycles, as well as almost any other make of sport/touring or standard bike.

You CAN Take It With You

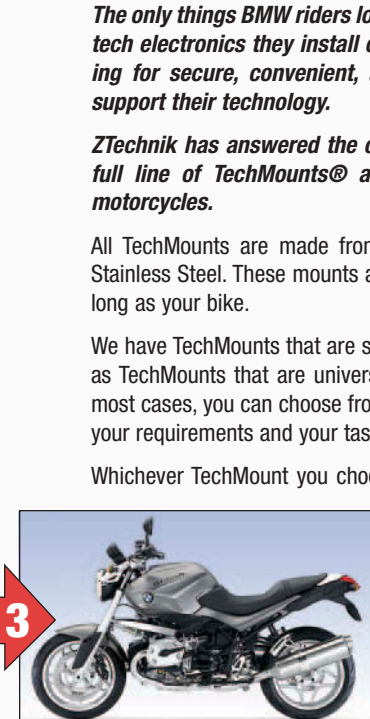

1

2

3

The only things BMW riders love as much as their bikes are the high-tech electronics they install on their bikes. Riders are always looking for secure, convenient, and attractive mounting platforms to support their technology.

ZTechnik has answered the call for tech support, and now offers a full line of TechMounts® and TechMount Accessories for BMW motorcycles.

All TechMounts are made from super strong 6061 T6 Aluminum and Stainless Steel. These mounts are designed to fit perfectly and to last as long as your bike.

We have TechMounts that are specially made for specific models as well as TechMounts that are universal to a number of BMW motorcycles. In most cases, you can choose from a range of different TechMounts to suit your requirements and your tastes.

Whichever TechMount you choose, you will also have a wide variety of accessories and adapter plates that allow you to mount almost any electronic device you may want to bring along on your ride.

So no matter where you go, you CAN take it with you!

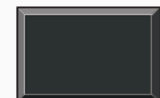

Anodized Black

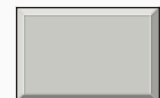

Anodized Silver



Brilliant Chrome

In addition to the many mounting options we have, TechMounts are also available in different sizes and finishes. Pick a tall mount to bring your device within easy reach, or a short mount to "hide" your device. And if you have a lot of bring-along items, you can outfit your bike with as many TechMounts as you want – or fit an optional Double Top Plate Kit for double duty capability.

TechMounts are finished in Anodized Black, Anodized Silver, and Brilliant Chrome. All screws and bolts are polished stainless steel.

All ZTechnik TechMounts include installation instructions, mounting hardware, installation tools, and Velcro® industrial fastener.



Hold It Right... There!

Mounting electronic accessories to your BMW motorcycle with TechMounts is as easy as 1-2-3!

- 1** What do you want to mount? A GPS? Radar detector? MP3 player? Something different?
- 2** Find the TechMount Accessory Adapter that will do the job (see below).
- 3** Find the TechMount(s) specific to your bike (see chart on page 68). That's all there is to it!

TechMount Accessory Adapters for Most Devices: GPS/Cell Phone/MP3/Satellite Radio/FRS Radio

- Z6201** GPS/XM Accessory Top Plate, Black
- Z6501** GPS/XM Accessory Top Plate, Silver
- Z6601** GPS/XM Accessory Top Plate, Chrome

Accessory Top Plate for mounting devices with the four bolt AMPS bolt pattern used by many GPS and SAT radios. Uses rubber expansion nuts to hold device secure and to isolate vibration. Works with Delphi XM Roady, XM Roady II, SkyFi, SkyFi 2, Garmin GPS Cradles, and R.A.M. GPS cradles. Not for mounting any Magellan GPS with nuts built into the back of the unit. Replaces any standard TechMount top plate. Anodized black or silver aluminum, or polished chrome.

Z6202 Quick Change Adaptor Plate, Black

Makes changing from one device to another quick and easy. Simply mount your GPS or satellite radio to the Quick Change Adaptor with the supplied hardware and slide it onto any standard TechMount top plate. The adaptor is held securely with one stainless thumbscrew from underneath. No tools are required. It has the AMPS four hole pattern used by Garmin, Magellan, Delphi XM and Sirius, and the two- and four-hole patterns used for mounting almost all R.A.M. style cradles. Black ABS plastic.

Z6208 Cell Phone/MP3 Holder, Black

Adjustable cradle for mounting small cell phone or I-Pod® (Nano, Mini or standard). This kit may be mounted directly to any standard top plate or to the Z6202 Quick Change Adapter. Holds accessories from 1.5 in. (40mm) to 2.8 in. (73mm). Overall height is 3.5 in. (89mm). Black ABS plastic.

Z6400 Single Pin Accessory Adaptor, Black

For mounting GPS or satellite radio cradles with a single square pin onto a Z6202 Quick Change Adapter Plate or Z6201/6501/6601 Accessory Adapter. Black ABS plastic.

Z6401 Four-Pin Accessory Adaptor, Black

For mounting GPS or Satellite radio cradles with four square holes onto a Z6202 Quick Change Adapter Plate or Z6201/6501/6601 Accessory Adapter. Black ABS plastic.

Z6402 Satellite Radio Antenna Mount, Black

Pre-drilled to mount onto any standard TechMount top plate or Z6202 Quick Change Adapter Plate. This bracket provides a secure and compact place to attach your XM radio antenna. Black powder coated steel.

Z6403 Garmin® GPS/XM Antenna Mount, Black

Makes mounting the Garmin GPS/XM radio antenna simple. This powder coated steel bracket mounts between the GPS cradle and the Techmount top plate. Black powder coated steel.



TechMount Accessory Adapters for Larger Devices: GPS/Cell Phone/MP3/Satellite Radio/FRS Radio

- Z6200** Wide Accessory Top, Black
- Z6500** Wide Accessory Top, Silver

Allows for the mounting of larger electronic devices, or two small devices side by side. Will work with any ZTechnik Accessory Mount product. Anodized black or silver aluminum.

Z6206 Large Cell Phone/MP3/FRS Radio Holder, Black

Adjustable cradle that makes mounting larger cell phones, PDA's and MP3 players safe and easy. Includes pin adapter plate needed to mount onto the Z6202 Quick Change Adapter or Z6201 GPS/XM Top Plate. Holds accessories 2.4 in. (60mm) to 3.6 (90mm) in. wide. Overall height is 4.1 in. (104mm). Black ABS plastic.



TechMount Accessory Adapters for Multiple Devices: Radar Detectors, Toll Booth Transponders, Etc.

- Z6203** ZTechnik Double Top Plate Kit, Silver
- Z6204** ZTechnik Double Top Plate Kit, Black

Replaces the single top plate of any ZTechnik Accessory Mount, offering twice the mounting surface area for carrying more than one electronic device. The dual 3 in. x 2.25" tops swivel independently. Anodized black or silver aluminum.

Choices, Choices, Choices

Z6100 TechMount; BMW Mirror Mount; Black

The Z6100 TechMount works beautifully on the RT and RS Series BMWs. The mount attaches effortlessly into existing, unused mirror holes on the handlebars. Once in place, the TechMount looks like it came stock on the bike. The Z6100 is finished in anodized black.

Z6110 TechMount; 1 1/8" Bar Mount; Chrome

Z6111 TechMount; 1" Bar Mount; Chrome

The Z6110 features an extra short stem and a compact overall design. The clean, "sanitary" look is preserved, but with the added convenience and function of a TechMount. The Z6111 TechMount is specially designed for the R 1200 C, but will fit any bike with 1" handlebars. It shares all the traits of the Z6110. Finished in bright polished chrome.

Z6120 TechMount; BMW K-Mount; Black

The Z6120 TechMount works beautifully on the K-RS and K-GT Series BMWs. Once in place, the TechMount looks like it came stock on the bike. Platform size is 3" x 2.25", and finish is anodized black.

Z6130 TechMount; 7/8" Bar Mount; Silver

Z6190 TechMount; 7/8" Bar Mount; Black

The Z6130 and Z6190 feature a medium long stem and a 3" x 2.25" platform. This mount is available in two finishes.

Z6131 TechMount Handlebar Control Mount; Black

This system is designed specifically for the BMW K 1200 R, K 1200 S, R and the R 1200 GS. It can be mounted on either the clutch or brake side to dlebar control's vertical pinch bolts. Platform size is 3" x 2.25". Finish is black.

Z6140 TechMount Fork Cap Mount; Black

This Fork Cap Mount replaces the fork tube oil filler bolt found on many motorcycles. As with all ball/socket systems, the shaft can be rotated to all angle and the top plate can be rotated 360 degrees as well as off-set left, center. Finish is anodized black.

Z6150 TechMount GT Mount; Silver

This attractive mount is made specially for the 2006 and later K 1200 GT, mates seamlessly with the bike's design and ergonomics. It fits on the mounting bolts and positions your electronic device within easy reach. Platform size is 3" x 2.25". Finish is anodized silver.

Z6191 TechMount; 7/8" Bar Mount; Double Top, Black

Z6291 TechMount; 7/8" Bar Mount; Double Top, Silver

These mounts are designed for any BMW motorcycle with 7/8" handlebars. Extra tall and wide, the dual 3" x 2.25" tops swivel independently. Finish is anodized black or anodized silver.

Z6192 TechMount; 7/8" Bar Mount; Black

Z6193 TechMount; 1 1/8" Bar Mount; Black

The Z6192 and Z6193 are sized for the new R 1200 GS's tapered handlebar. The Z6192 fits the grip end area and the Z6193 fits the wider center section. Both are finished in anodized black.

Z6194 TechMount Windshield Bracket Mount; Silver

The Z6194 Windshield Bracket Mount is designed specifically for the BMW R 1200 GS. When an eye level, center location is best for your accessory, this is the mount to use. The Z6194 mounts onto the front fairing support above the gauges and can be mounted left or right of center, or two can be mounted side by side. Platform size is 3" x 2.25". Finish is anodized silver. See the Z6195 for GS Adventure models.

Z6195 TechMount Windshield Bracket Mount; Silver

The Z6195 Windshield Bracket Mount is specifically for the BMW R 1200 GS Adventure, and has a taller arm to provide clearance over the Adventure's windshield brackets. All other features are the same as the Z6194. Platform size is 3" x 2.25". Finish is anodized silver. (Not shown)

Z6700 TechMount; 7/8" Bar Mount; Camo

This off-road handlebar mount is a universal clamp system designed for round tube handlebars 7/8" in diameter that requires only 1/2" of bar space. The ball and socket design used on this mount allows a wide range of movement, making installation at complex angles possible. The top plate can be rotated 360 degrees, as well as offset left, right or center. Platform size is 3" x 2.25". Comes in special anodized camo finish.



Experience Sound Perfection

ZBI-ULTIMA XL

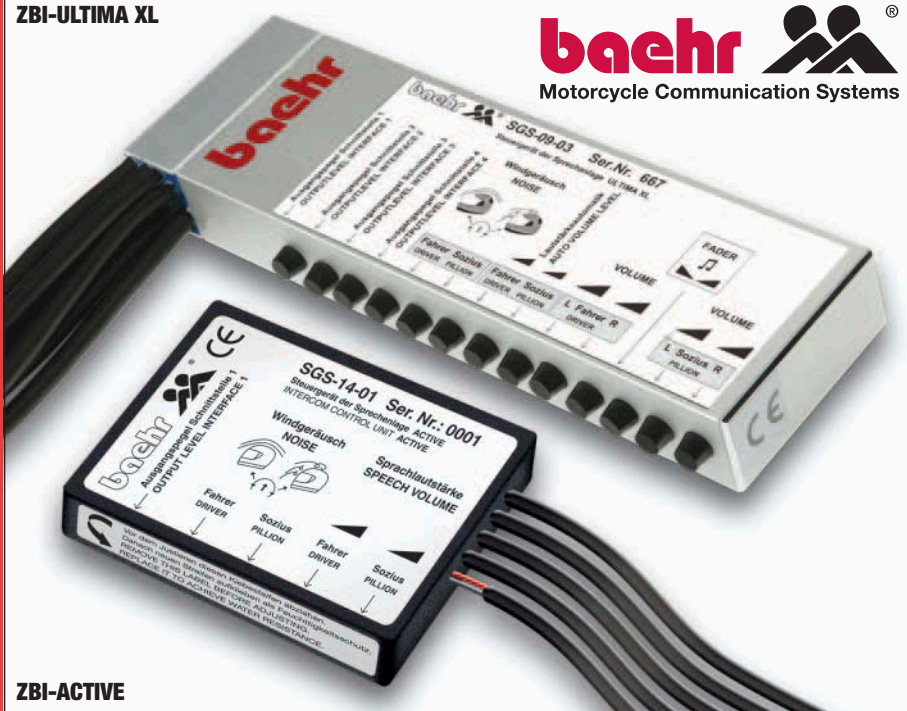

ZBI-ACTIVE

- ZBI-K1200LT Baehr SilverLine K 1200 LT System
- ZBI-ULTIMAXL Baehr SilverLine ULTIMA XL System
- ZBI-VERSOXL Baehr SilverLine VERSO XL System
- ZBI-ACTIVE Baehr BlackLine ACTIVE System
- ZBI-SOLO Baehr BlackLine SOLO System

Whether you are looking for an affordable voice-activated intercom system for you and a passenger, the best in bike-to-bike communications, or (for the demanding rider who wants it all) a completely versatile audio/communications system, Baehr was the perfect solution for you.

With features like advanced electronic circuitry, standard music audio inputs, prioritized universal interface connections, automatic volume control, wind/noise suppression, individual rider/passenger settings, rugged construction, and easy installation, you will not find a better motorcycle communications system anywhere.

**Experience Sound Perfection...
Experience Baehr!**

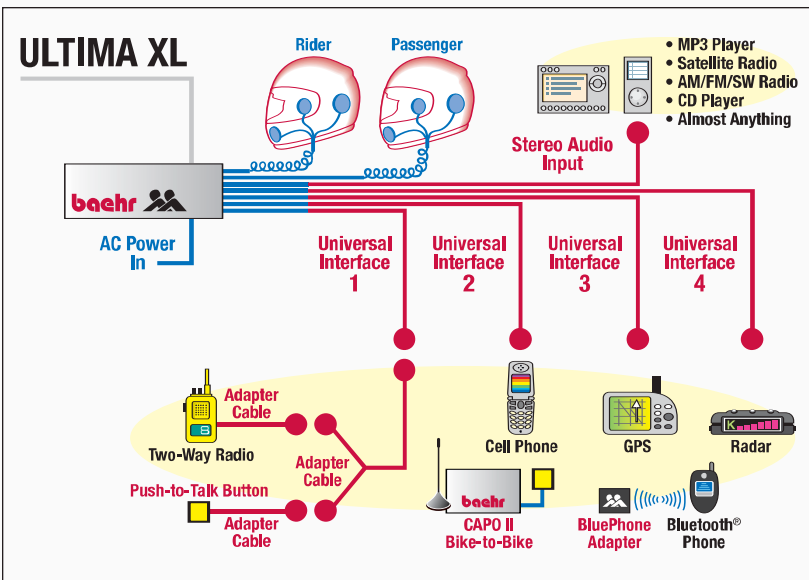
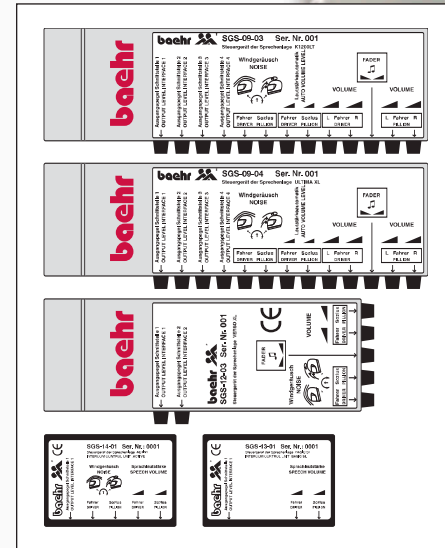

*Ask for the complete BaehrUSA catalog (#ZBI-20041).
See next page for contact information.*

Each kit include two sets of premium stereo headphones and directional microphones, plus all the cables you need for installation into your bike (SOLO kit includes cables for rider only – passenger cables are optional).

Baehr headphones and microphones work with any full-face helmet. Boom and mini-boom mics are available for open-face and modular helmets.

Baehr also offers a wide range of adapter and accessory cables for complete connectivity with virtually any type of electronic device.

If you want audiophile quality sound in your helmet, Baehr delivers!

